

SPECTRE



**PRODUCT
CATALOGUE**

2024

trojan tools Ltd

CONTENTS

Hand Tools

Measuring Tools and Levels 03

Hammers & Mallets 04

Knives & Blades 05

Spanners & Spanner Sets 06

Gripping Tools 07

Clamps / Vices / Bolsters & Chisels 08

Hex Screwdrivers, Ratchets & Bits 09

General / Other 10

Chucks & Keys 11

Power Tool Accessories

Circular / Grinding / Flap / Depress 12

Oscillating 13

Bit, Kits, Sets 14

Bit Sets 15

Guns, Shovels, Wrecking Bar 16

Hand Files 17 -19

Trojan

Jobber Drills 20-21

Electrical

Lights & Cables 22-23

Outdoor

Augers, Shovels, Rakes, Crowbars 24



All prices include VAT

MEASURING

Combination Square

12" Combination Square, Zinc Alloy

SP-17337

Hardened and tempered blade for extra durability
Metric and imperial graduations
Spirit level and scriber included in square head handle
Locating screws on all heads ensure quick and easy assembly

SRP £6.99

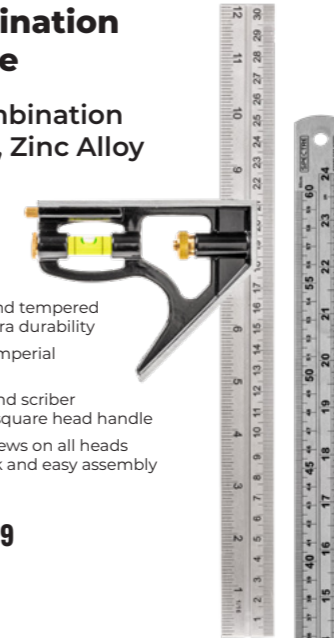

Steel Ruler

Steel Rulers 12" & 24"

Heavy duty stainless steel rulers. Precision made with clear markings. Graduations in metric and imperial. Handy conversion scale on reverse. In display wallet.

Code	Size	SRP
SP-17335	12 inch / 30cm	£1.99
SP-17336	24 inch / 60cm	£2.99



Dual-Marked Steel Tape Measure

Spectre Professional Dual-Marked Steel Tape Measure

Ergonomically designed bevel case. Fits snugly into the palm of your hand. Intelligently manufactured to handle any job with ease. Features metric and imperial blade markings. Width: 25mm

Code	Length	Width	SRP
SP-17265	5m / 16ft	25mm	£3.99
SP-17266	8m / 26ft	25mm	£5.99



Spirit Level

Spectre Box Section Spirit Level with Magnet

SP-17267

High Quality Aluminium Box Section Spirit Level with 3 Vials (one horizontal, two vertical) for measuring at any angle.

All products have an accuracy of +/- 0.5mm.

Magnetic Base
Both Edges Milled.
Shock resistant.

Code	Size	SRP
SP-17267	600mm	£13.99
SP-17268	1000mm	£18.99
SP-17269	1200mm	£21.99



All prices include VAT

MALLET



Mallet
16oz Rubber Mallet

SP-17348
Rubber head helps minimise marring and surface damage. Tough rubber head molded to a genuine Hickory handle.

SRP £4.99

Hammer
16mm Cross Pein Hammer 150g
SP-17347

Pein hammer with forged head, round ground face and long cross pein. Comes with genuine Hickory handle.

SRP £4.99



Hammer
16oz One-piece Claw Hammer
SP-17350

All-steel highly polished one-piece construction hammer. The narrow shaft helps weight distribution and balance. Fitted with a moulded vinyl grip that is bonded to the hammer shaft for cushioning and user comfort.

SRP £12.99



4

Hammer
16oz Two-colour Fibreglass Claw Hammer
SP-17351

This claw hammer has a polished steel head which has been correctly hardened and tempered. Fitted with a fibreglass handle which is lightweight, extremely strong and resistant to moisture. Head type: curved claw.

SRP £6.99



Utility Knife
Folding Lock Back Utility Knife

SP-17328
Folding lock back utility knife with heavy duty zinc-alloy housing and non-slip rubber grip. Includes 5 spare blades.

SRP £5.99



Utility Knife
Spectre Folding Lock-back Utility Knife
SP-17264

The knife opens easily with one hand, and the locking action secures blade in an open position. Lightweight and robust aluminium body with belt clip. Featuring quick-release blade change mechanism. Ergonomic design with textured rubber grips for increased comfort. Ideal for Trade Professionals and DIYers alike. Supplied with 5pcs SK5 blades.

SRP £6.99

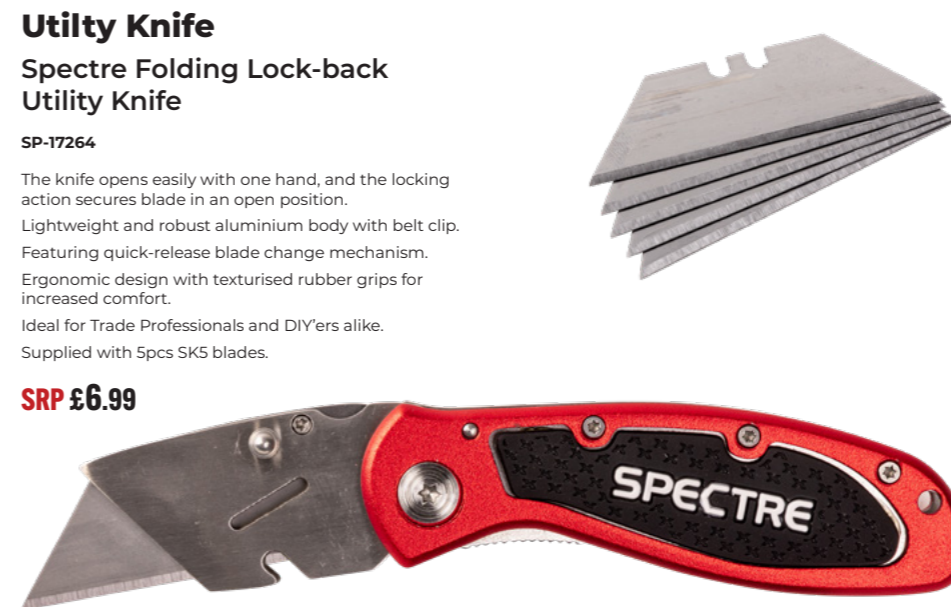

Utility Knife
Snap Off Utility Knife

Ideal for DIY jobs & light industrial use. Quick and efficient cutting without the need for sharpening. Automatic blade change. Ribbed easy grip handle for comfort and during use.

Blade length 135mm. Cartridge with 3 x 9mm blades with 12 snap off sections.

Blade length 165mm. Cartridge with 3 x 18mm blades with 6 snap off sections.



Trimming Knife
Retractable Trimming Knife

SP-17330
Ergonomic design retractable trimming knife. Zinc alloy construction with a die-cast body. Additional blade storage in handle.

SRP £2.99



Knife Blades
Trimming Knife Blades 10pc
SP-17332

10 Pack replacement blades with 2 notches. Suitable for use with most trimming knives. Complete with plastic dispenser for safe storage.

SRP £1.19



Knife Blades
Replacement Blades 18mm 5pc
SP-17333

5 pack replacement blades for 18mm snap off utility knife. Each blade has 6 cutting points and compatible with most 18mm trimming knives. Come with protective storage case.

SRP £0.99

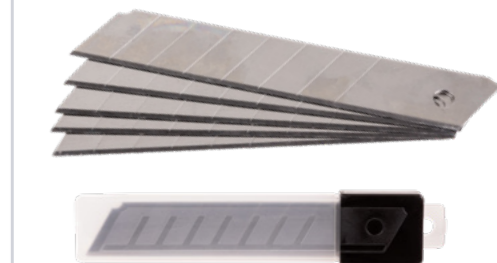

5

Metric Spanner Set

Spectre 9pc. Chrome Vanadium Metric Combination Spanner Set in Plastic Case

SP-17001

Chrome vanadium combination spanner set with hardened and tempered mirror polished heads. Nickel chrome plated. DIN 3113

SRP £11.99



Metric Spanner Set

Spectre 18pc. Chrome Vanadium Metric Combination Spanner Set in Wallet

SP-17002

Chrome vanadium combination spanner set with hardened and tempered mirror polished heads. Nickel chrome plated. DIN 3113

SRP £24.99



Spanners

Combination Spanners

CRV Combination Spanner. Hardened and tempered with a mirror polish finish. Manufactured to DIN 3113



Code	Size	SRP
SP-17290	6mm	£0.69
SP-17291	7mm	£0.75
SP-17292	8mm	£0.79
SP-17293	9mm	£0.85
SP-17294	10mm	£0.89
SP-17295	11mm	£0.99
SP-17296	12mm	£1.09
SP-17297	13mm	£1.19
SP-17298	14mm	£1.29
SP-17299	15mm	£1.49
SP-17300	16mm	£1.69
SP-17301	17mm	£1.79
SP-17302	18mm	£1.99
SP-17303	19mm	£2.19
SP-17304	20mm	£2.59
SP-17305	21mm	£2.79
SP-17306	22mm	£2.99
SP-17307	23mm	£3.39
SP-17308	24mm	£3.79
SP-17309	25mm	£4.19
SP-17310	26mm	£4.49
SP-17311	27mm	£5.49
SP-17312	28mm	£5.99
SP-17313	29mm	£6.99
SP-17314	30mm	£6.99
SP-17315	32mm	£7.99

Spanner Set

Spectre 6pc Jumbo Combination Spanner Set

SP-17101

Chrome vanadium combination spanner set with hardened and tempered mirror polished heads. Nickel chrome plated. Supplied in a durable plastic tool roll and arranged in size order. DIN 3113

SRP £119.99



Metric Spanner Set

Spectre 25pc. Chrome Vanadium Metric Combination Spanner Set in Wallet

SP-17003

Chrome vanadium combination spanner set with hardened and tempered mirror polished heads. Nickel chrome plated. DIN 3113

SRP £54.99



Pipe Wrench

Spectre Pipe Wrench

Heavy duty drop-forged steel with powder coated finish, knurled thumbwheel adjustment. Corrosion-resistant.

Hardened, ground and polished jaws.

For use on pipework and fittings in awkward positions.

Code	Size	SRP
SP-17004	300mm / 12"	£4.99
SP-17005	350mm / 14"	£6.99
SP-17006	450mm / 18"	£9.99
SP-17007	600mm / 24"	£14.99



WRENCHES

Waterpump Plier

Spectre CR-V Steel Drop Forged Box-Joint Waterpump Plier

Chrome vanadium waterpump plier with hardened jaws.

Joint Positions: 7

Chrome vanadium steel pliers with durable, corrosion-resistant coating and ergonomic dipped rubber handles.

Code	Size	SRP
SP-17146	10"	£4.99
SP-17147	12"	£6.99



Pliers

3pc Plier Set

SP-17338

Inductive hardened cutting edge with comfortable soft grip handles. High quality carbon steel material with micro finish to prevent corrosion. Contains: 6" long nose pliers, 7" combination pliers, 6" diagonal cutting pliers

SRP £11.99



Pliers

3pc Mini Plier Set

SP-17339

Induction hardened cutting edge with comfortable soft grip handles. High quality carbon steel drop forged with micro finish to prevent corrosion. Contains: mini long nose pliers, mini combination pliers, mini diagonal cutting pliers.

SRP £7.99

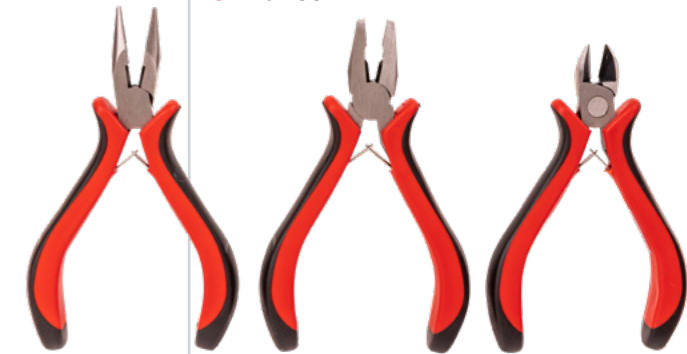

Adjustable Wrench

Spectre Chrome Plated Drop Forged Adjustable Wrench

Coating: Chrome Plated
Material: Drop Forged Carbon Steel with Hardened Jaw

Code	Size	SRP
SP-17140	150mm / 6"	£3.99
SP-17141	200mm / 8"	£4.99
SP-17142	300mm / 10"	£5.99
SP-17143	???mm / 12"	£7.49
SP-17144	???mm / 15"	£17.99
SP-17145	???mm / 18"	£34.99



Sash Clamp Spectre Sash Clamp

Suitable for exerting very high pressure. Made from T section bar with cast iron heads and feet.

Code	Size	SRP
SP-17009	1200mm / 48 inch	£17.99
SP-17010	1500mm / 60 inch	£19.99



CLAMP

Malleable Iron G-Clamp Spectre Malleable Iron G-Clamp

Fine thread with reinforced shoulders for strength. SG cast iron frame. Suitable for a wide variety of metalworking and woodworking applications. Black phosphate spindles provide a smooth operation and maximum clamping pressure. Tommy bar handle. Swivel shoe.

Code	Size	SRP
SP-17011	100mm / 4 inch	£4.99
SP-17012	150mm / 6 inch	£6.99
SP-17013	200mm / 8 inch	£8.99



Engineers Bench Vice Spectre Heavy Duty Engineers Bench Vice

For medium to heavy-duty applications. Manufactured from high quality grey cast iron steel with hardened jaws. Features a rust-resistant, powder-coated finish. Has immense strength under compression with excellent shock absorbing capabilities. Machined to close tolerances and are designed for smooth operation and reliability. Main spindle is fully enclosed to protect the threads from contamination and damage. Features a machined anvil and replaceable steel jaw plates. Can apply a clamping pressure of up to one ton between the jaws. Safety stop prevents the slide from being accidentally separated from the body.

Code	Size	SRP
SP-17094	100mm	£39.99
SP-17095	150mm	£69.99

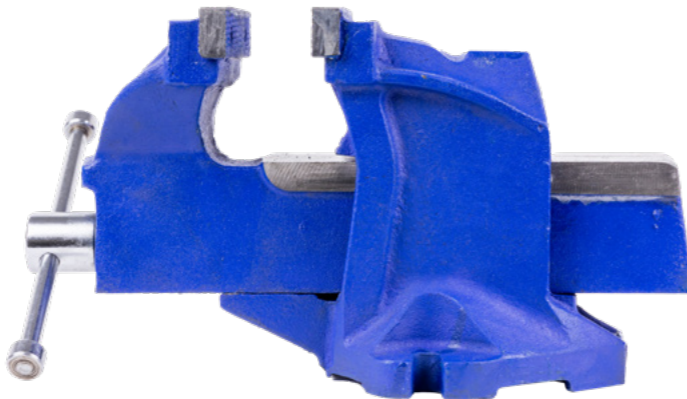

Cold Chisel Spectre Cold Chisel with Dual Moulded Guard (BS3066)

Solid drop forged EN9 steel, with dual moulded guard to BS3066. Powder coated for corrosion resistance. Made to be robust and durable and can withstand many applications.

Code	Size	SRP
SP-17250	200 x 25mm	£5.99
SP-17251	250 x 25mm	£5.99
SP-17252	300 x 25mm	£6.99



Brick Bolster Spectre Brick Bolster with Dual Moulded Guard (BS3066)

Solid drop forged EN9 steel with shock-absorbing hand guard to BS3066. Hardened cutting edges. Sharpened cutting edges.

Code	Size	SRP
SP-17247	57mm	£5.99
SP-17248	75mm	£6.99
SP-17249	100mm	£7.99



Hex Key Set 30pc Hex Key Set- CRV

30pcs of chrome vanadium steel hex key set, complete with folding case. 15pcs in both long arm and short arm series. 15pcs in imperial measurements covering sizes 0.028 to 3/8in. 15pcs in metric sizes from 0.7mm up to 10mm.

SRP £11.99



Screwdriver Set 6pc Precision Screwdriver Set

6 piece screwdriver set covering both flat and phillips head tips. Cr-V steel with heat treated blades and magnetic tips. Comes with comfortable handle for use and storage case. Contains flat head sizes (2,2.5 & 3mm) and phillips (PH0, PH00 & PH000)

SRP £3.99



Hex Key Set 8pcs Metric Folding Hex Key Set

High quality CRV hex key set. Sizes: 1.5, 2, 2.5, 3, 4, 5, 6, 8mm.

SRP £3.99



Hex key set 8pcs TORX Folding Hex Key Set

High quality CRV torq key set. Sizes: T9-T10-T15-T20-T25-T27-T30-T40

SRP £3.99

Screwdriver Set Screwdriver Bit Set S2

30PC Color Ring Batch Head, S2, Nickel Plated Surface, Color Rings: Sizes: PH1, PH22, PH3, PZ1, PZ22, PZ3, SL3, SL4, SL5, SL6, H3, H4, H5, H6, T10, T15, T20, T25, T27, T30, T40, T10 (with hole), T15 (with hole), T20 (with hole), T25 (with hole), T27 (with hole), T30 (with hole), T40 (with hole). 1PC 25mm Bead Changer, CR-V, Heat Treated, Nickel Plated Surface. 1PC Quick Clamp, CR-V, Heat Treated, Hexagonal Rod in Black, Chrome Plated Surface

SRP £6.99



Screwdriver Set 6pc Screwdriver Set

6 piece screwdriver set covering both flat and phillips head tips. Cr-V steel with heat treated blades and magnetic tips. Comes with comfortable handle for use. Contains flat head sizes (5 x 75mm, 6 x 100mm & 8 x 150mm) and phillips (PH1 X 75mm, PH2 x 100mm & PH3 x 150mm)

SRP £6.99



Drill Bits Set Spectre 15-Piece 1/4in Screwdriver Bit Set

Spectre 15 Piece Screwdriver Bit Set Colour Coded + Holder Pozzi PZ2 PH2 Slotted. Professional quality S2 grade 25mm bits in the key sizes for everyday use. Colour-coded for easy selection. Supplied with Carry Case. Set Includes: 25mm x 1/4" HEX Screwdriver Bits - 2x PZ1, 2x PZ3, 2x PH2, 6x PZ2, 1x PH1, 1x PH3 65mm Quick Release Stainless Magnetic Bit Holder

SRP £8.99



Ratchet Handle Set 12PC 72th Ratchet Handle Set CRV+72T

Chrome vanadium Ratchet sets with a Matt finish. 12pc 1/4" Contains: 1/4" Quick ratchet handle - 72T, 1/4" Dr. Extension Bar 3" 1/4" Metric Sockets. 12pc 3/8" Contains: 3/8" Quick ratchet handle - 72T, 3/8" Dr. Extension Bar 6" 3/8" Metric Sockets. 12pc 1/2" Contains: 1/2" Quick ratchet handle - 72T, 1/2" Dr. Extension Bar 5" 1/2" Metric Sockets

Code	Size	Socket (mm)	SRP
SP-17344	1/4	4 5 6 7 8 9 10 11 12 13	£11.99
SP-17345	3/8	10 11 12 13 14 15 16 17 18 19	£17.99
SP-17346	1/2	8 10 11 12 13 14 15 17 19 22 24	£23.99



Magnetic Bit Holder Spectre Standard Magnetic Bit Holder 60mm Long

Bulk/Loose Product Overall length 60mm Carbon steel

SRP £0.49



Hex Shank 1/4" hex shank magnetic bit holder

Retail card product

SRP £0.49



Plastic Funnel

Spectre Plastic Funnel

Polyethylene funnel Suitable for use with petrol, oil, water etc.
Rigid straight spout.
Grip tab with integral hanging eye.
Material: Polyethylene

Code	Size	SRP
SP-17021	150mm / 6"	£0.99
SP-17022	200mm / 8"	£1.99



Plastic Funnel

Spectre 250mm (10 Inch) Tractor or Garage Funnel with Filter

SP-17023

Polyethylene funnel suitable for use with petrol, oil, water etc.
Rigid straight spout.
Grip tab with integral hanging eye.
Material: Polyethylene

SRP £6.99



Oil Jug

Spectre Plastic Oil Jug with Screw Lid and Cap

SP-17018

Opaque Polyethylene body allows visual measurement.
Offers metric measurement.
Screw top lid and end dust cap

Code	Size	SRP
SP-17018	1 Litre	£2.99
SP-17019	3 Litre	£4.49
SP-17020	5 Litre	£7.99



All-Steel Keyless Chuck

Spectre 13mm (1/2in x 20) All-Steel Keyless Chuck for Drill/Drivers

Professional, heavy-duty chuck with carbide jaws for extra grip.
Suitable for most makes of electric or cordless drills.

Code	Size	SRP
SP-17043	Heavy Duty	£8.99
SP-17044	Medium Duty	£4.99



Self-Locking Chuck

Spectre 13mm (1/2 x 20) 1.5mm Heavy Duty Self-Locking Chuck

SP-17134

Professional, heavy-duty chuck with carbide jaws for extra grip.
Suitable for most makes of electric or cordless drills.
Capacity: 13mm.
Fitment: 1/2 inch x 20 UNF.

SRP £14.99



Immersion Heater Box Spanner

Spectre 86mm (3 3/8in AF) Immersion Heater Box Spanner System states 122mm

SP-17017

Provides a firm non-slip grip on immersion heater elements.
Deep box design allows easy access to heaters that are surrounded by insulation or are recessed.
Supplied complete with a tommy bar to help provide added leverage when removing over tight elements.
Manufactured from heavy gauge steel.

SRP £9.99

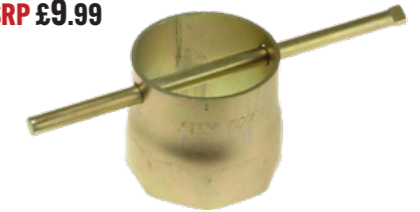

Carpentry Set

Title Spectre 5pc Carpentry Set in Wooden Box (No.4 Plane, Block Plane, Square, Bevel, Gauge)

SP-17177

This Spectre traditional carpenters tool kit has been specially commissioned to provide the essentials you need for working with wood. The kit contains four traditional woodworking tools in a wooden tool box for transport and storage.

SRP £49.99

Made from hardwood, brass and steel, the tools have been carefully chosen to provide a versatile platform on which to build a fully featured tool kit, or to add to an existing one.

All the tools are made to the highest quality from the finest hardwood, brass and steel.

Supplied in a lined wooden case with metal hinges.

Features

A marking gauge is essential for laying out scribe lines during joinery applications, and the included tool is an especially versatile model which can be used as a mortice gauge for marking out mortice and tenon joints.

The try square gives you a 90° reference point and straight edge for ensuring your cuts are as square and accurate as possible.

The sliding bevel enables you to accurately transfer angles and is often used when cutting dovetail joints.

The No.4 smoothing plane is a classic design which has been around for over 100 years, during which time it has become the most popular hand plane for finishing wood.

The block plane is ideally suited for working on end grain and smaller surface areas.

The tool kit includes a wooden storage box to keep everything together. This is a super gift for the professional, enthusiast or apprentice.

Set includes:

- No.4 Smoothing Plane
- 230mm Try Square
- 230mm Sliding Bevel
- Mortice and Marking Gauge
- Hinged wooden case
- 60,1/2 Block Plane



Manhole Lifting Keys

Spectre Pair of Manhole Lifting Keys

Designed to lift and remove most standard non-locking manhole covers, drain gully covers and access panels.
Zinc plated for rust protection.

Rectangular with long T shaped key ends and large triangular shaped handles that provide a positive grip.

Code	Size	SRP
SP-17015	170mm / 7"	£5.99
SP-17016	620mm / 15"	£9.99

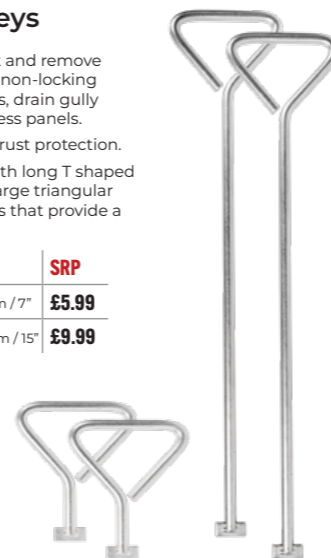

Wire Brush

4 Row Steel Wire Brush

SP-17340

Designed for cleaning all rough surfaces on a variety of materials to remove paint, dirt, rust and stubborn deposits.

SRP £1.49



M14 Quick-Nut

Spectre Heavy Duty M14 Quick Release Quick-Nut

SP-17137

Replaces standard M14 flanges on grinders, to enable fast tool-less disc changes.

Fits Bosch, Makita, Dewalt and more.

Quality lock nut for attaching resin fibre discs to Flexipads backing pads.

Thread M14 x 2.

Typically used with corded grinders.



SRP £11.99

M14 Quick-Nut

Spectre Standard Duty M14 Quick-Nut

SP-17136

Quality lock nut for attaching resin fibre discs to Flexipads backing pads.

With machined grip to outer edge.

Thread M14 x 2.

Typically used with cordless grinders.



SRP £9.99

UK Radiator Key

Spectre UK Radiator Key

SP-17014

Used for venting excess air from radiators.
Solid brass radiator key.
Ideal for storing in a toolbox or kitchen drawer.



SRP £0.99

Pillar Drill Machine Chuck with Key

Spectre 1-13mm All Steel Machine Chuck (JT6) with Key

SP-17135

Designed for use on pillar drills.

Chuck capacity: 13mm.

Fitment: Tapered Jacobs mount.

Supplied with chuck key.



SRP £7.99

Machine Chuck with Key

Spectre 1-13mm All Steel Machine Chuck (1/2x20) with Key

SP-17139

For use with corded and cordless drills.

1/2in x 20 UNF thread.

Capacity 13mm.

Complete with chuck key.



SRP £7.99

Chuck Adaptor

Spectre 1/2in x 20 SDS-Plus Chuck Adaptor

SP-17045

Enables a 1/2" x 20 threads female threaded chuck to be fitted to an SDS drill.

Fully compatible with all the major power tool brands, including Makita, Dewalt and Bosch.

Not to be used on hammer action.



SRP £0.99

TCT Circular Saw Blade

Spectre 136mm 20-tooth TCT Circular Saw Blade

SP-17204

Circular saw blade, designed for use with handheld portable cordless circular saws. The blade features a thinner kerf and body, which reduces friction allowing for a lighter feed pressure and protecting the motor of your saw. The positive hook angle and tooth configuration enable fast, clean cuts in soft and hardwoods.

Bore Size: 20mm (Reducers for 10mm and 16mm included)

SRP £3.99



TCT Circular Saw Blade Aggressive Cutting

Spectre 165mm 24-tooth TCT Circular Saw Blade

SP-17205

The Spectre SP-17205 is a 165mm 24 tooth circular saw blade, designed for use with handheld portable cordless circular saws. The blade features a thinner kerf and body, which reduces friction allowing for a lighter feed pressure and protecting the motor of your saw. The positive hook angle and tooth configuration enable fast, aggressive cuts in soft and hardwoods.

Bore Size: 20mm (Reducers for 10mm and 16mm included)

SRP £3.99



TCT Circular Saw Blade

Spectre 165mm 40-tooth TCT Circular Saw Blade

SP-17206

Circular saw blade, designed for use with handheld portable cordless circular saws. The blade features a thinner kerf and body, which reduces friction allowing for a lighter feed pressure and protecting the motor of your saw. The positive hook angle and tooth configuration enable fast, clean cuts in soft and hardwoods.

Bore Size: 20mm (Reducers for 10mm and 16mm included)

SRP £4.99



Multitool Blade Kit

Spectre 4pc Multitool Blade Kit

SP-17218

Supplied With:

- 1 x 68mm Wood Plunge Cut Blade.
- 1 x 34mm Bi-metal Plunge Blade.
- 1 x 34mm Wood Plunge Cut Blade.
- 1 x 34mm Precision Wood Blade

SRP £11.99



Wood Plunge Cut Blade

Spectre General Duty 34mm Wood Plunge Cut Blade (50pcs/box)

SP-17208

Plunge cutting saw blade with rounded cutting edge to match the cutting motion of the machine and ensure precise cuts.

Material: HCS SK5.

Finish: Black painted + laser mark

SRP £1.99

Per piece



Wood Plunge Cut Blade

Spectre General Duty 65mm Wood Plunge Cut Blade (50pcs/box)

SP-17209

Plunge cutting saw blade with rounded cutting edge to match the cutting motion of the machine and ensure precise cuts.

Material: HCS SK5.

Finish: Black painted + laser mark

SRP £1.99

Per piece



TCT Circular Saw Blade

Spectre 184mm 40-tooth TCT Circular Saw Blade

SP-17207

Circular saw blade, designed for use with handheld portable cordless circular saws. The blade features a thinner kerf and body, which reduces friction allowing for a lighter feed pressure and protecting the motor of your saw. The positive hook angle and tooth configuration enable fast, clean cuts in soft and hardwoods.

Bore Size: 20mm (Reducers for 10mm and 16mm included)

SRP £5.99



Universal Cutting Disc (Single)

Spectre Industrial Quality Universal Cutting Disc

For steel including stainless.

Manufactured to comply with EN12413.

Fast cutting.

Long life.

For 22.23mm spindle.

No of Pieces: 1

Code	Size	SRP
SP-17202	115 x 1mm	£1.00
SP-17270	125 x 1mm	£1.49
SP-17271	230 x 1.9mm	£1.99



Universal Cutting Disc (Pack of 10)

Spectre 115 x 1mm Industrial Quality Universal Cutting Disc (10pcs/Tin)

SP-17203

Size: 115 x 1mm.

For steel including stainless.

Manufactured to comply with EN12413.

For 22.23mm spindle.

Fast cutting.

Long life.

No of Pieces: 10

SRP £7.99



Cutting Disc

Spectre Depressed Centre Cutting Disc

Depressed centre gives you more clearance to cut at tighter angles or flush with the surface of your workpiece. Strong fibreglass mesh reinforces the disc, making it safer to work with.

Manufactured in accordance with EN 12413 safety standard. Max speed is 80 m/s and max speed rpm is 13300 rpm.

Code	Size	SRP
SP-17272	115 x 2.5mm	£1.00
SP-17273	115 x 3.2mm	£1.09
SP-17274	125 x 2.5mm	£1.09
SP-17275	125 x 3.2mm	£1.19
SP-17276	230 x 3.2mm	£2.49



Grinding Disc

Grinding Disc

Suitable for grinding rough metal edges with rapid succession. Conforms to EN 12413:2019.

Max speed m/s is 80 m/s and a max speed rpm of 12,200rpm.

Code	Size	SRP
SP-17277	115 x 6mm	£1.29
SP-17278	125 x 6mm	£1.39
SP-17279	230 x 6mm	£3.99



Flap Disc

Zirconia Alumina Flap Disc (VSM)

A flap disc is an abrasive product used to contour and shape metal. These are made from Zirconia Alumina which allows for high performance edge grinding. Zirconia alumina is self-sharpening and holds up exceptionally well under high temperatures and pressures, leading to a more efficient product and a longer life span. Comes in a variety of grits from 40 to 120. Conforms to EN 13743. Max speed of 80 m/s and a max rpm of 13300rpm.

Code	Size	SRP	Code	Size	SRP
SP-17280	115mm Grit:40	£1.99	SP-17285	125mm Grit:40	£2.99
SP-17281	115mm Grit:60	£1.99	SP-17286	125mm Grit:60	£2.99
SP-17282	115mm Grit:80	£1.99	SP-17287	125mm Grit:80	£2.99
SP-17283	115mm Grit:100	£1.99	SP-17288	125mm Grit:100	£2.99
SP-17284	115mm Grit:120	£1.99	SP-17289	125mm Grit:120	£2.99



Bi-Metal Plunge Cut Blade

Spectre Heavy Duty 34mm M42 Bi-Metal Plunge Cut Blade (50pcs/box)

SP-17210

Fits most makes of multi-tools.

Suitable for cutting metal, wood and PVC.

Finish: Black painted+laser mark

SRP £2.49

Per piece



Bi-Metal Plunge Cut Blade

Spectre Heavy Duty 65mm M42 Bi-Metal Plunge Cut Blade (50pc/box)

SP-17211

Fits most makes of multi-tools.

Suitable for cutting metal, wood and PVC.

Finish: Black painted+laser mark

SRP £2.99

Per piece



Japanese-tooth Precision Plunge Blade

Spectre General Duty 34mm Japanese-tooth Precision Plunge Blade (50pc/box)

SP-17212

Material: HCS SK5.

Finish: Black painted+laser mark

SRP £1.99

Per piece



Japanese-tooth Precision Plunge Blade

Spectre General Duty 68mm Japanese-tooth Precision Plunge Blade (50pc/box)

SP-17213

Material: HCS SK5.

Finish: Black painted+laser mark

SRP £2.49

Per piece



Bi-Metal Plunge Cut Blade

Spectre Heavy Duty 88mm M42 Bi-Metal Plunge Cut Blade (50pc/box)

SP-17214

Fits most makes of multi-tools.

Suitable for cutting metal, wood and PVC.

Finish: Black painted+laser mark

SRP £3.99

Per piece



Wood Plunge Cut Blade

Spectre General Duty 88mm Wood Plunge Cut Blade (50pc/box)

SP-17215

Plunge cutting saw blade with rounded cutting edge to match the cutting motion of the machine and ensure precise cuts.

Material: HCS SK5.

Finish: Black painted + laser mark

SRP £1.99

Per piece



BITS, KITS, SETS

Multitool Accessory Kit

Spectre 27pc Multitool Accessory Kit

SP-17216

Supplied With:
 1pc 20mm Fine Teeth Wood Blade;
 1pc 34mm Fine Teeth Wood Blade;
 1pc 34mm Bi Metal Blade;
 1pc 88mm Segment Saw Blade;
 1pc 65mm Carbide-tipped Segment Saw Blade;
 1pc S.S Scraper 52x72mm;
 1pc Sanding Pad Flat 80mm;
 20pcs Sanding Discs:(G40,G80,G100,G120)x5.

SRP £24.99



Hammer and Chisel Bit Set

Spectre 17pc SDS+ Hammer and Chisel Bit Set

SP-17229

The set is supplied in a tool roll:

12xHammer Drill Bits.
 5x110mm; 5.5x110mm; 6x110mm;
 8x110mm; 10x110mm; 6x160mm;
 7x160mm; 8x160mm; 10x160mm;
 8x210mm; 10x210mm; 14x260mm
 2xPoint Chisel
 14x140mm; 14x250mm
 3xFlat Chisel
 14x140x20mm;
 14x250x20mm;
 14x250x40mm

SRP £29.99



Worktop Router Bit

Spectre Worktop Router Bit

TCT Premium Router cutter designed to give a fast and precise cut with the added advantage of tungsten end tip, making it suitable for plunging.

Extra long life, twin straight fluted cutters, suitable for cutting high quality laminates giving a quality finish for the top tradesman.

Can be used in an extensive range of timbers and hard plastics.



Code	Size	SRP
SP-17233	1/2 x 1/2 x 50	£5.99
SP-17234	1/2 x 1/2 x 63	£6.99

Plumbers Holesaw Set

Spectre 9pc Plumbers Holesaw Set

SP-17062

Supplied with:
 6pcs hole saws: 19, 22, 29, 38, 44, 57 mm
 9.5mm hex shank arbor with HSS polit drill; fits hole saw 12- 30mm
 11mm hex shank arbor with HSS polit drill; fits hole saw 32- 152mm
 Mandrel adapter M42 material

SRP £31.99

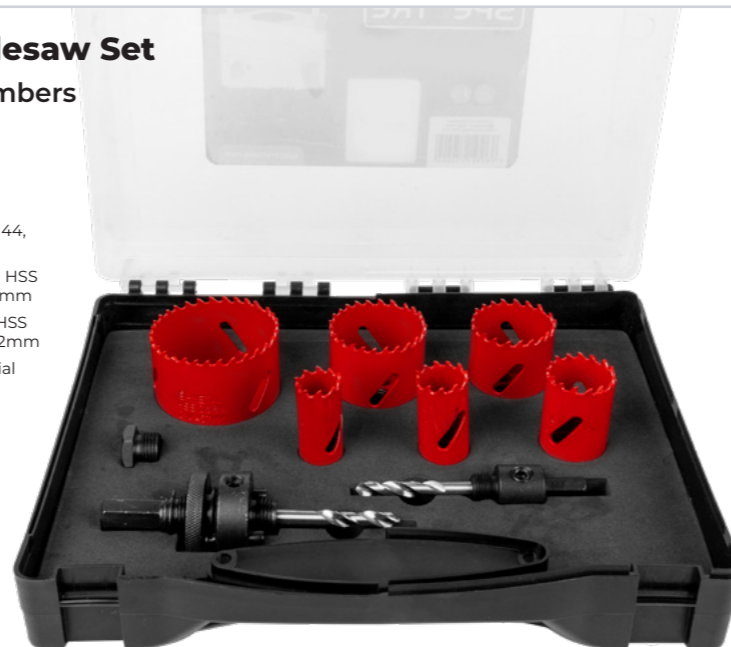

Drill Bits Set

Spectre 5-Piece HSS Brad-Point Wood bit Set (4,5,6,8,10mm)

SP-17258

Spectre Performance 5 Piece HSS PRO Brad Point Wood Drill Bit Set 4 5 6 8 10mm - Includes hard case.

Straight Shank.

Flute Design - special flute shape prevents jamming and ensures speedy chip extraction.

W-point provides accurate positioning for starting the hole.

Spur cutting edge reduces splintering and ensures a smooth clean hole.

HSS Construction - offering the best combination of strength, heat and wear resistance.

SRP £4.99



Drill Bits Set

Spectre 5-Piece Masonry Drill Set (4,5,6,8,10mm)

SRP £6.99

SP-17257

Spectre Performance Black 5 Piece Masonry Drill Bit Set 4 5 6 8 10mm.

The hexagon shank prevents chunk slippage.

1/4" quick change shank suitable for quick change adaptors.

These Tungsten Carbide Masonry drill bits are suitable for drilling in concrete and masonry, brick, block, tile, marble etc



Electricians Holesaw Set

Spectre 9pc Electricians Holesaw Set

SP-17063

The Spectre 9pc Electricians Holesaw Set is ideal for professional use due to the robust nature of this set. Constructed from High quality M42 Bi-metal this set is ideal for many applications such as cutting steel, cast iron, aluminium, plastic and wood. This set is supplied in a handy plastic carry case to keep the holesaws organised, easy to locate and to prevent loss or damage to them.

SRP £31.99

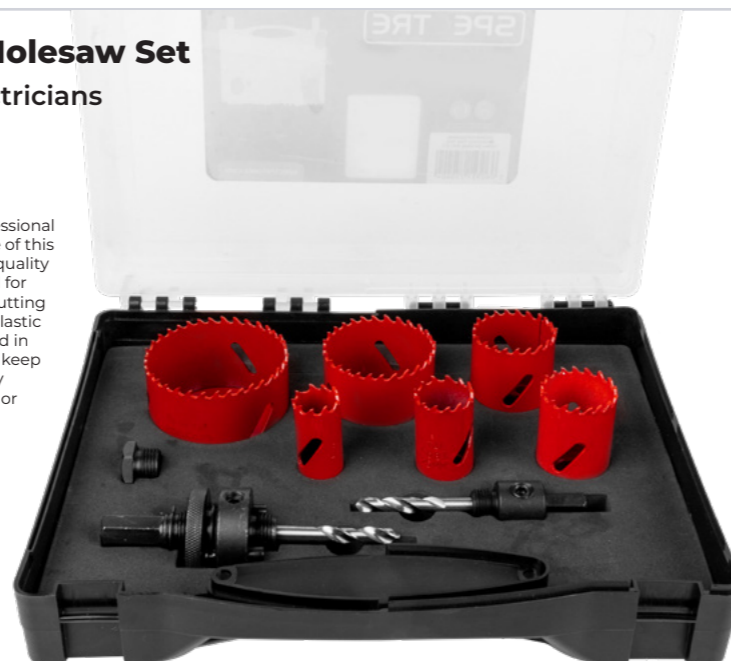

Drill Bits Set

Spectre 5-Piece HSS Metal Drill Bit Set (4,5,6,8,10mm)

SP-17259

Spectre Performance 5 Piece HSS Metal Drill Bit Set Bright Finish 4 5 6 8 10mm - Includes hard case.

Parallel Straight Shank - precise engineering for accurate hole sizes.

Fast Drilling in Metal.

HSS Construction - offering the best combination of strength, heat and wear resistance.

SRP £4.99



Drill Bits Set

Spectre 6-Piece Flat Wood Bit Set (10,13,16,19,22,25mm)

SRP £8.99

SP-17261

This Spectre 6 Piece Flat Bit Set is ideal for most types of wood and has a flat-bit grooved head for improved centering and discharge. Precision Ground Cutting Edge Hex Shank drill bits for faster penetration and cleaner hole boring. Perfect for Woodworking tasks. The hexagon shank prevents chunk slippage.

1/4" quick change shank suitable for impact drivers and quick change adaptors.

6 x Flat Wood Drill Bits 10 12 16 18 20 25mm In hard carry case



Caulking Gun

Caulking gun 11"

SP-17317



Heavy duty steel skeleton frame with aluminium handle and steel trigger. Suitable for precise application of sealants and adhesives. Nozzle cleaning pin built into the handle. Takes standard 310ml and 400ml cartridges.

SRP £5.99

Grease Gun

Spectre 500cc Grease Gun with 2 Nozzles for Bulk or Cartridge Loading

SP-17008



SRP £14.99

Side lever grease gun develops up to 10,000 psi - 690 bar of pressure. Features an aluminium diecast head with an easy locking plunger system. Ergonomic pump handle grip. Positive grip plunger handle. Bulk loader system with an air release valve, combine to make it very efficient and easy to use. Variable lever stroke feature is built-in for use in confined areas. 4 jaw hydraulic coupler ensures that the grease goes exactly where it is needed. 500g (16oz) capacity, the gun can be bulk filled by its suction action. Will also accept 400g grease cartridges. Supplied with a rigid nozzle and a flexible extension hose.

Coal Shovel

Spectre 6" Coal Shovel

SP-17150

Ideal for shovelling coal or for use as a dustpan. Raised shoulders prevent spillage. Powder coated pressed steel construction.

SRP £2.99



Dust Pan

Spectre 9" Dust Pan

SP-17151

Pressed steel head with durable hardwood handle. Ideal for collecting dust and helps retain dirt and debris until ready to be emptied.

SRP £5.49



Hex-Shaped Wrecking Bar

Spectre Hex-Shaped Wrecking Bar

Hexagonal shape - Premier contractors wrecking bar manufactured from one-piece, forged EN9 solid steel for strength. Powder coated for corrosion resistance. Wide surface for ease when using. Material: EN9 Forged solid steel. Shape Design: Hexagonal



Code	Length	Width	SRP
SP-17098	18"	16mm	£4.99
SP-17099	24"	16mm	£7.99
SP-17100	36"	18mm	£9.99

NEEDLE FILES

6 Piece Set

Part No.	Length mm	Cut	Shank Diameter	Box Quantity	SRP
66480079	160	0	3.0	1	£1.49
66480080	160	2	3.0	1	£1.49

Set comprises of 1 of each:- Hand, Flat, Round, Half-Round, Square and Three-Square.



12 Piece Set

Part No.	Length mm	Cut	Shank Diameter	Box Quantity	SRP
66480081	160	0	3.0	1	£1.49
66480082	160	2	3.0	1	£1.49

Set comprises of 1 of each:- Hand, Flat, Round, Half-Round, Square and Three-Square.



Hand Cut

Part No.	Length mm	Cut	Shank Diameter	Box Quantity	SRP
66480001	160	00	3.0	10	£1.49
66480002	160	0	3.0	10	£1.49
66480003	160	1	3.0	10	£1.49
66480004	160	2	3.0	10	£1.49
66480005	160	4	3.0	10	£1.49
66480006	160	6	3.0	10	£1.49

Flat Cut

Part No.	Length mm	Cut	Shank Diameter	Box Quantity	SRP
66480007	160	00	3.0	10	£1.49
66480008	160	0	3.0	10	£1.49
66480009	160	1	3.0	10	£1.49
66480010	160	2	3.0	10	£1.49
66480011	160	4	3.0	10	£1.49
66480012	160	6	3.0	10	£1.49

Round Cut

Part No.	Length mm	Cut	Shank Diameter	Box Quantity	SRP
66480013	160	00	3.0	10	£1.49
66480014	160	0	3.0	10	£1.49
66480015	160	1	3.0	10	£1.49
66480016	160	2	3.0	10	£1.49
66480017	160	4	3.0	10	£1.49
66480018	160	6	3.0	10	£1.49

Half Round Cut

Part No.	Length mm	Cut	Shank Diameter	Box Quantity	SRP
66480019	160	00	3.0	10	£1.49
66480020	160	0	3.0	10	£1.49
66480021	160	1	3.0	10	£1.49
66480022	160	2	3.0	10	£1.49
66480023	160	4	3.0	10	£1.49

Square Cut

Part No.	Length mm	Cut	Shank Diameter	Box Quantity	SRP
66480026	160	0	3.0	10	£1.49
66480027	160	1	3.0	10	£1.49
66480028	160	2	3.0	10	£1.49
66480029	160	4	3.0	10	£1.49
66480030	160	6	3.0	10	£1.49

Three Square Cut

Part No.	Length mm	Cut	Shank Diameter	Box Quantity	SRP
66480031	160	00	3.0	10	£1.49
66480032	160	0	3.0	10	£1.49
66480033	160	1	3.0	10	£1.49
66480034	160	2	3.0	10	£1.49
66480035	160	4	3.0	10	£1.49
66480036	160	6	3.0	10	£1.49

Knife Cut

Part No.	Length mm	Cut	Shank Diameter	Box Quantity	SRP
66480040	160	2	3.0	10	£1.49

Engineers' Hand File



Part No.	Length	Cut	Cross Section mm	Box Quantity	SRP
65300101	100	1	10.4 x 2.5	10	£1.39
65300102	100	2	10.4 x 2.5	10	£1.49
65300103	100	3	10.4 x 2.5	10	£1.69
65300151	150	1	16 x 4	10	£1.79
65300152	150	2	16 x 4	10	£1.99
65300153	150	3	16 x 4	10	£1.99
65300201	200	1	20 x 5	10	£1.99
65300202	200	2	20 x 5	10	£1.99
65300203	200	3	20 x 5	10	£2.39
65300251	250	1	25 x 6.3	10	£2.69
65300252	250	2	25 x 6.3	10	£2.79
65300253	250	3	25 x 6.3	10	£2.99
65300301	300	1	30 x 6.7	5	£3.59
65300302	300	2	30 x 6.7	5	£3.69
65300303	300	3	30 x 6.7	5	£3.99
65300351	350	1	34.5 x 7.6	5	£4.99
65300352	350	2	34.5 x 7.6	5	£5.29
65300353	350	3	34.5 x 7.6	5	£6.39

Engineers' 3 Square Files



Part No.	Length	Cut	Cross Section mm	Box Quantity	SRP
65420101	100	1	6.4	10	£1.59
65420102	100	2	6.4	10	£1.59
65420103	100	3	6.4	10	£1.89
65420151	150	1	10	10	£1.79
65420152	150	2	10	10	£1.89
65420153	150	3	10	10	£2.29
65420201	200	1	14	10	£2.29
65420202	200	2	14	10	£2.39
65420203	200	3	14	10	£2.89
65420251	250	1	17	10	£2.99
65420252	250	2	17	10	£2.99
65420253	250	3	17	10	£3.79
65420301	300	1	20	5	£3.69
65420302	300	2	20	5	£3.89
65420303	300	3	20	5	£4.69

Engineers' Square Files



Part No.	Length	Cut	Cross Section mm	Box Quantity	SRP
65480151	150	1	6.3	10	£1.89
65480152	150	2	6.3	10	£1.89
65480153	150	3	6.3	10	£2.29
65480201	200	1	8	10	£2.19
65480202	200	2	8	10	£2.29
65480203	200	3	8	10	£2.69
65480251	250	1	10	10	£2.89
65480252	250	2	10	10	£2.99
65480253	250	3	10	10	£3.59
65480301	300	1	12.5	5	£3.59
65480302	300	2	12.5	5	£3.79
65480303	300	3	12.5	5	£4.49

Engineers' Half Round Files



Part No.	Length	Cut	Cross Section mm	Box Quantity	SRP
65540151	150	1	15.8 x 4.5	10	£2.49
65540152	150	2	15.8 x 4.5	10	£2.59
65540153	150	3	15.8 x 4.5	10	£2.99
65540201	200	1	20.7 x 5.9	10	£2.99
65540202	200	2	20.7 x 5.9	10	£2.99
65540203	200	3	20.7 x 5.9	10	£3.59
65540251	250	1	25.5 x 7.3	10	£3.99
65540252	250	2	25.5 x 7.3	10	£4.09
65540253	250	3	25.5 x 7.3	10	£4.69
65540301	300	1	30.4 x 8.7	5	£4.99
65540302	300	2	30.4 x 8.7	5	£4.99
65540303	300	3	30.4 x 8.7	5	£5.99
65540352	300	2	30.4 x 8.7	5	£7.99

Engineers' Round Files



Part No.	Length	Cut	Cross Section mm	Box Quantity	SRP
65600101	100	1	4	10	£1.59
65600102	100	2	4	10	£1.59
65600103	100	3	4	10	£1.79
65600151	150	1	6.3	10	£1.69
65600152	150	2	6.3	10	£1.79
65600153	150	3	6.3	10	£1.89
65600201	200	1	8	10	£1.99
65600202	200	2	8	10	£2.09
65600203	200	3	8	10	£2.49
65600251	250	1	10	10	£2.49
65600252	250	2	10	10	£2.69
65600253	250	3	10	10	£2.99
65600301	300	1	12	5	£3.29
65600302	300	2	12	5	£3.49
65600303	300	3	12	5	£3.69
65600352	350	2	14	5	£5.29

Thread Restoring Files



Part No.	Thread	Box Quantity	SRP
66490001	Metric	1	£29.99
66490002	BSW/BSF	1	£29.99
66490003	UNC/UNF	1	£29.99
66490004	BSP	1	£49.99

HOLDER

14" Milled File Blade Holder



Part No.	Size	Box Quantity	SRP
66090024	14"	1	£31.99

Hand file, Dreadnought



Part No.	Length mm	Cut	Cross Section mm	Box Quantity	SRP
66090008	350	9TPI	36 x 5.5	1	£12.99

Hand blade Millenicut Image as guide only



Part No.	Length mm	Cut	Cross Section mm	Box Quantity	SRP
66090023	350	9TPI	36 x 5	1	£12.29

MILLED TOOTH FILES

Hand File, Tanged Dreadnought



Part No.	Length mm	Cut	Cross Section mm	Box Quantity	SRP
66090001	200	9TPI	21 x 5.8	10	£8.99
66090002	250	9TPI	26 x 7	10	£9.99
66090003	300	9TPI	31 x 8.3	5	£10.99
66090004	350	9TPI	36 x 8.8	5	£12.99

Half Round, Tanged Dreadnought



Part No.	Length mm	Cut	Cross Section mm	Box Quantity	SRP
66090005	250	9TPI	23 x 7	10	£9.99
66090006	300	9TPI	27 x 9	5	£10.99

Hand File, Tanged Millenicut



Part No.	Length	Cut	Cross Section mm	Box Quantity	SRP
66090009	200	9TPI	21 x 5.8	10	£9.99
66090010	200	13TPI	21 x 5.8	10	£9.79
66090011	250	9TPI	26 x 7	10	£9.99
66090012	250	13TPI	26 x 7	10	£9.99
66090014	300	9TPI	31 x 8.3	5	£12.19
66090015	300	13TPI	31 x 8.3	5	£12.19
66090017	350	9TPI	36 x 8.8	5	£12.99

Half Round, Tanged Millenicut



Part No.	Length mm	Cut	Cross Section mm	Box Quantity	SRP
66090020	250	9TPI	23 x 7	10	£10.29
66090021	300	9TPI	27 x 9	5	£11.99

DIAMOND FILES

Hand



Part No.	Length mm	Cut	Shank Diameter	Box Quantity	SRP
66660001	160	Coarse	3.0	1	£9.99
66660002	160	Med	3.0	1	£9.99

Flat



Part No.	Length mm	Cut	Shank Diameter	Box Quantity	SRP
66660005	160	Med	3.0	1	£9.99

Round



Part No.	Length mm	Cut	Shank Diameter	Box Quantity	SRP
66660007	160	Coarse	3.0	1	£9.99
66660008	160	Med	3.0	1	£9.99
66660009	160	Fine	3.0	1	£9.99

Half Round



Part No.	Length mm	Cut	Shank Diameter	Box Quantity	SRP
66660011	160	Med	3.0	1	£9.99

Square



Part No.	Length mm	Cut	Shank Diameter	Box Quantity	SRP
66660014	160	Med	3.0	1	£9.99

Square



Part No.	Length mm	Cut	Shank Diameter	Box Quantity	SRP
66660016	160	Coarse	3.0	1	£5.99
66660017	160	Med	3.0	1	£14.99

6 Piece Set



Part No.	Length mm	Cut	Shank Diameter	Box Quantity	SRP
66660020	160	Med	3.0	1	£57.99
66660021	160	Fine	3.0	1	£57.99

Set comprises of 1 of each:-
Hand, Flat, Round, Half-Round,
Square and Three-Square.



HAND FILES

Jobber Drills DIN 388 RN

Flute Geometry:
Standard Helix,
Right-Hand Spiral Point

Angle:
118 Surface

Treatment:
Bright - 0.5mm and below.
Blue - 0.6mm and above.

Application:
General purpose
engineering drills

JOBBER DRILLS



Part No.	Diameter mm	Flute Length mm	Overall length mm	SRP
00.30JOB	0.30	3	19	£3.39
00.40JOB	0.40	5	20	£2.89
00.45JOB	0.45	5	20	£2.69
00.50JOB	0.50	6	22	£2.19
00.52JOB	0.52	6	22	£3.79
00.55JOB	0.55	7	24	£2.79
00.60JOB	0.60	7	24	£2.39
00.65JOB	0.65	8	26	£2.59
00.70JOB	0.70	9	28	£2.19
00.72JOB	0.72	9	28	£2.69
00.75JOB	0.75	9	28	£2.19
00.80JOB	0.80	10	30	£1.79
00.85JOB	0.85	10	30	£1.99
00.90JOB	0.90	11	32	£1.99
00.92JOB	0.92	11	32	£2.79
00.95JOB	0.95	11	32	£1.99
01.00JOB	1.00	12	34	£1.49
01.10JOB	1.10	14	36	£1.59
01.15JOB	1.15	14	36	£2.29
01.20JOB	1.20	16	38	£1.59
01.30JOB	1.30	16	38	£1.49
01.40JOB	1.40	18	40	£1.49
01.45JOB	1.45	18	40	£1.99
01.50JOB	1.50	18	40	£1.29
01.55JOB	1.55	20	43	£1.99
01.60JOB	1.60	20	43	£1.29
01.65JOB	1.65	20	43	£1.99
01.70JOB	1.70	20	43	£1.39
01.75JOB	1.75	22	46	£1.89
01.80JOB	1.80	22	46	£1.39
01.85JOB	1.85	22	46	£1.89
01.90JOB	1.90	22	46	£1.39
01.95JOB	1.95	24	49	£1.69
02.00JOB	2.00	24	49	£1.09
02.05JOB	2.05	24	49	£1.49
02.10JOB	2.10	24	49	£1.29
02.15JOB	2.15	27	53	£1.49
02.20JOB	2.20	27	53	£1.29
02.25JOB	2.25	27	53	£1.79
02.30JOB	2.30	27	53	£1.29
02.35JOB	2.35	27	53	£1.79
02.40JOB	2.40	30	57	£1.29
02.45JOB	2.45	30	57	£1.79
02.50JOB	2.50	30	57	£1.09
02.55JOB	2.55	30	57	£1.79
02.60JOB	2.60	30	57	£1.29
02.65JOB	2.65	30	57	£1.79

Part No.	Diameter mm	Flute Length mm	Overall length mm	SRP
02.70JOB	2.70	33	61	£1.29
02.75JOB	2.75	33	61	£1.79
02.80JOB	2.80	33	61	£1.29
02.85JOB	2.85	33	61	£1.29
02.90JOB	2.90	33	61	£1.29
02.95JOB	2.95	33	61	£1.89
03.00JOB	3.00	33	61	£1.19
03.10JOB	3.10	36	65	£1.39
03.20JOB	3.20	36	65	£1.39
03.30JOB	3.30	36	65	£1.29
03.40JOB	3.40	39	70	£1.49
03.50JOB	3.50	39	70	£1.19
03.60JOB	3.60	39	70	£1.59
03.70JOB	3.70	39	70	£1.39
03.75JOB	3.75	39	70	£2.29
03.80JOB	3.80	43	75	£1.59
03.90JOB	3.90	43	75	£1.69
04.00JOB	4.00	43	75	£1.39
04.10JOB	4.10	43	75	£1.49
04.20JOB	4.20	43	75	£1.49
04.30JOB	4.30	47	80	£1.79
04.40JOB	4.40	47	80	£1.89
04.50JOB	4.50	47	80	£1.59
04.60JOB	4.60	47	80	£1.89
04.70JOB	4.70	47	80	£1.99
04.80JOB	4.80	52	86	£1.99
04.85JOB	4.85	52	86	£2.69
04.90JOB	4.90	52	86	£1.99
05.00JOB	5.00	52	86	£1.79
05.10JOB	5.10	52	86	£2.19
05.20JOB	5.20	52	86	£2.19
05.25JOB	5.25	52	86	£3.09
05.30JOB	5.30	52	86	£2.29
05.40JOB	5.40	57	93	£2.39
05.50JOB	5.50	57	93	£2.39
05.60JOB	5.60	57	93	£2.49
05.70JOB	5.70	57	93	£2.59
05.80JOB	5.80	57	93	£2.69
05.90JOB	5.90	57	93	£2.69
06.00JOB	6.00	57	93	£2.29
06.10JOB	6.10	63	101	£2.89
06.20JOB	6.20	63	101	£2.89
06.25JOB	6.25	63	101	£3.69
06.30JOB	6.30	63	101	£2.89
06.40JOB	6.40	63	101	£2.99
06.50JOB	6.50	63	101	£2.69
06.60JOB	6.60	63	101	£3.19

Part No.	Diameter mm	Flute Length mm	Overall length mm	SRP
06.70JOB	6.70	63	101	£3.39
06.80JOB	6.80	69	109	£2.99
06.90JOB	6.90	69	109	£3.59
07.00JOB	7.00	69	109	£2.99
07.10JOB	7.10	69	109	£3.79
07.20JOB	7.20	69	109	£3.69
07.25JOB	7.25	69	109	£4.79
07.30JOB	7.30	69	109	£3.79
07.40JOB	7.40	69	109	£4.09
07.50JOB	7.50	69	109	£3.49
07.60JOB	7.60	75	117	£4.29
07.80JOB	7.80	75	117	£4.39
08.00JOB	8.00	75	117	£3.89
08.10JOB	8.10	75	117	£4.79
08.20JOB	8.20	75	117	£4.89
08.30JOB	8.30	75	117	£4.69
08.40JOB	8.40	75	117	£4.99
08.50JOB	8.50	75	117	£4.39
08.60JOB	8.60	81	125	£5.49
08.70JOB	8.70	81	125	£5.59
08.80JOB	8.80	81	125	£5.59
08.90JOB	8.90	81	125	£5.89
09.00JOB	9.00	81	125	£4.99
09.10JOB	9.10	81	125	£5.89
09.20JOB	9.20	81	125	£6.29
09.25JOB	9.25	81	125	£8.59
09.30JOB	9.30	81	125	£6.09
09.40JOB	9.40	81	125	£6.39
09.50JOB	9.50	81	125	£5.59
09.60JOB	9.60	87	133	£6.59
09.70JOB	9.70	87	133	£6.79
09.80JOB	9.80	87	133	£6.89
09.90JOB	9.90	87	133	£7.09
10.00JOB	10.00	87	133	£6.19
10.10JOB	10.10	87	133	£8.69
10.20JOB	10.20	87	133	£8.49
10.25JOB	10.25	87	133	£11.19
10.30JOB	10.30	87	133	£8.79
10.40JOB	10.40	87	133	£9.29
10.50JOB	10.50	87	133	£6.69
10.60JOB	10.60	87	133	£9.59
10.70JOB	10.70	94	142	£10.69
10.80JOB	10.80	94	142	£10.29
10.90JOB	10.90	94	142	£10.09
11.00JOB	11.00	94	142	£7.79
11.10JOB	11.10	94	142	£11.29
11.20JOB	11.20	94	142	£11.59

Part No.	Diameter mm	Flute Length mm	Overall length mm	SRP
11.25JOB	11.25	94	142	£14.29
11.30JOB	11.30	94	142	£11.89
11.40JOB	11.40	94	142	£11.79
11.50JOB	11.50	94	142	£8.59
11.60JOB	11.60	94	142	£12.69
11.70JOB	11.70	94	142	£12.69
11.75JOB	11.75	94	142	£14.49
11.80JOB	11.80	94	142	£12.79
11.90JOB	11.90	101	151	£13.49
12.00JOB	12.00	101	151	£9.49
12.10JOB	12.10	101	151	£15.99
12.20JOB	12.20	101	151	£15.59
12.40JOB	12.40	101	151	£15.89
12.50JOB	12.50	101	151	£10.49
12.60JOB	12.60	101	151	£17.69
12.80JOB	12.80	101	151	£17.39
12.90JOB	12.90	101	151	£17.79
13.00JOB	13.00	101	151	£11.59
13.20JOB	13.20	101	151	£19.59
13.50JOB	13.50	108	160	£18.49
13.70JOB	13.70	108	160	£20.79
13.80JOB	13.80	108	160	£22.99
14.00JOB	14.00	108	160	£18.79
14.50JOB	14.50	114	169	£24.49
15.00JOB	15.00	114	169	£23.09
15.50JOB	15.50	120	178	£28.59
16.00JOB	16.00	120	178	£27.39
16.50JOB	16.50	125	184	£33.89
17.00JOB	17.00	125	184	£30.39
17.50JOB	17.50	130	191	£40.09
18.00JOB	18.00	130	191	£35.89
19.00JOB	19.00	135	198	£42.29
20.00JOB	20.00	140	205	£47.99



MILLING MAINTENANCE

TDB Cutting Oil, Paste and Liquid

Part No.	Size	SRP
T/TDB400	400ml Aerosol	£9.99
T/TDB500G	500g Paste	£19.99
T/TDB500	500ml Liquid	£19.99
T/TDB5	5 Litre Liquid	£99.99



LIGHTS & CABLES

20W LED Tasklight 110V Spectre 20W LED Tasklight, 1x16A Outlet Socket, 3M Cable

SP-17179

SMD LED Task Light with Power Take-Off

- 16Amp outlet socket for linking with other lights or tools (6.25A current - max 1,000W).

Maximum Link: 20 Lights.

- Supplied with 3 Metre Cable.
- Glare free 2,000 Lumens of light output
- Made in China

Cable Length: 3m
Wattage: 20W
Lumens: 2000
Overall Size: 27 x 24cm
Socket Ampage: 16A



DISCONTINUED LIMITED STOCK



Cable Reel Core 110V Cable Reel with 2 x 16A Sockets

With Handle for a firmer and more comfortable grip. Safety protector Thermal Cut out- disconnects the current when the power exceeds the capacity limit.

Comes with 2 x 16A sockets. IP44 rated and a core size of 1.5mm.

Code	Length	Width
SP-17035	25m	1.5mm
SP-17121	50m	1.5mm

DISCONTINUED LIMITED STOCK

STD 20W LED Floodlight Spectre 230V STD 20W LED Floodlight, 3Mx1.0mm Cable and 13A Plug

SP-17191

Buy 6 or more Spectre Floodlights and save an additional 30%.

Mix and match across all Spectre Floodlights
LED Tripod Sitelight designed for both commercial or domestic use.

Die-casting Aluminum body, Powder coating, Each head that provides a high light output of 1800 lumens.

Color Temp. 6400-6500K

Cable Length: 3m

DISCONTINUED LIMITED STOCK



STD 20W LED Floodlight Spectre 230V STD Twin 20W LED Floodlight, 3Mx1.5mm Cable and 13A Plug

SP-17193

Buy 6 or more Spectre Floodlights and save an additional 30%.

Mix and match across all Spectre Floodlights
LED Tripod Sitelight designed for both commercial or domestic use.

Die-casting Aluminum body, Powder coating, Each head that provides a high light output of 1800 lumens.

Color Temp. 6400-6500K

Cable Length: 3m

DISCONTINUED LIMITED STOCK



HD 30W LED Floodlight Spectre 110V HD 30W LED Floodlight, 5Mx1.5mm Cable, 2x16A or 13A Outlet and 16A or 13A Plug

Buy 6 or more Spectre Floodlights and save an additional 30%.

Mix and match across all Spectre Floodlights
LED Tripod Sitelight designed for both commercial or domestic use.

Die-casting Aluminum body, Powder coating, Each head that provides a high light output of 2700 lumens.

IP54 Rated.

Color Temp. 6400-6500K

Core Size: 1.5mm

Cable Length: 5m

Code	Size
SP-17184	16A
SP-17185	13A

DISCONTINUED LIMITED STOCK



HD 30W LED Floodlight Spectre 110V HD Twin 30W LED Floodlight, 5Mx1.5mm Cable, 2x16A or 13A Outlet and 16A or 13A Plug

Buy 6 or more Spectre Floodlights and save an additional 30%.

Mix and match across all Spectre Floodlights
LED Tripod Sitelight designed for both commercial or domestic use.

Die-casting Aluminum body, Powder coating, Each head that provides a high light output of 2700 lumens.

IP54 Rated.

Color Temp. 6400-6500K

Core Size: 1.5mm

Cable Length: 5m

Code	Size
SP-17186	16A
SP-17187	13A

DISCONTINUED LIMITED STOCK



STD 20W LED Minipod Spectre STD 20W LED Minipod, 1800 lumens

LED Portable Site Light.
designed for both commercial or domestic use.
Die-casting Aluminum body, Powder coating,
Color Temp. 6400-6500K

Core Size: 1mm
Cable Length: 3m
Wattage: 20W
Lumens: 1800

Code	Voltage	Plug
SP-17188	110V	16A
SP-17189	230V	13A

DISCONTINUED LIMITED STOCK



HD 30W LED Minipod Spectre HD 30W LED Minipod, 2700 lumens

LED Portable Site Light.
designed for both commercial or domestic use.
Die-casting Aluminum body, Powder coating,
Color Temp. 6400-6500K
Lumens: 2700

Code	Voltage	Plug
SP-17182	110V	16A
SP-17183	230V	13A

DISCONTINUED LIMITED STOCK



Yellow Coupler Spectre 110V 3Pin Yellow Coupler IP44

Power Plus 110V Coupling Socket - Plastic
Coupling socket for 14mm trailing lead.
For site and industrial use
Long life and durable
Available in yellow colour
Ingress Protection: IP44
Certified to IEC 60309 standard

Code	Size
SP-17114	16A
SP-17116	32A

DISCONTINUED LIMITED STOCK



Yellow Plug Spectre 110V 3Pin Yellow plug IP44

Power Plus Yellow Plug 110V- Plastic
110V replacement plugs for use with 14mm trailing leads.
For site and industrial use
Ingress Protection: IP44
Long life and durable
Available in yellow colour
Certified to IEC 60309 standard

Code	Size
SP-17113	16A
SP-17115	32A

DISCONTINUED LIMITED STOCK



OUTDOOR

Insulated Cross Digger

Spectre Insulated Cross Digger

SP-17173

Ideal for use for the professional contractor.

Made to be robust and durable and can withstand many applications.

BS3020.2011 2000V compliant.

All steel welded construction with wide opening blades.

Scissor action, close the handles to close blades

Designed to protect users working in close proximity to live cables and wires.

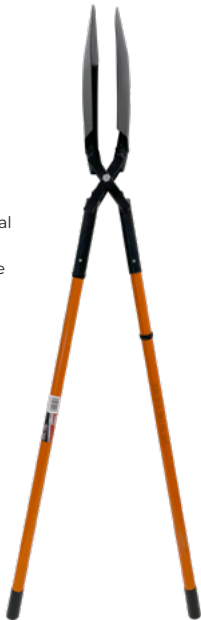

DISCONTINUED
LIMITED STOCK

Trenching Fork

Spectre Insulated Trenching Fork

SP-17168

Ideal for the professional contractor for safety from hidden underground electricity cables.

Featuring a heavy-duty fibreglass shaft and handle. Manufactured to BS8020-2011 designed to protect users working in close proximity to live cables and wires. Guaranteed to 1000V.



DISCONTINUED
LIMITED STOCK

Post Hole Auger

Spectre 5" Post Hole Auger

SP-17165

Ideal for use for the professional contractor.

Made to be robust and durable Steel and can withstand many applications.

Steel corkscrew blade with fixed tubular steel handle.

For drilling 127mm (5") diameter holes.

Earth removal by rotation of steel corkscrew blade.

Auger has smaller locating screw for easy hole start.

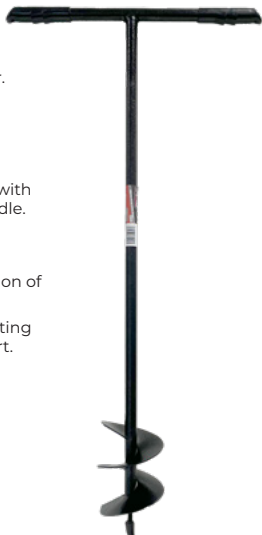

DISCONTINUED
LIMITED STOCK

Insulated Crowbar

Spectre Insulated Crowbar 5ft

SP-17174

Ideal for use for the professional contractor.

Made to be robust and durable and can withstand many applications.

BS3020.2011 2000V compliant.

Insulated shaft is manufactured using a solid fibreglass core that is coated with an abrasive resistant orange polymer coating.

Designed to protect users working in close proximity to live cables and wires.



DISCONTINUED
LIMITED STOCK

SPECTRE TOOLS



ORDER NOW

Phone

01271 313 500

Email

sales@trojantools.co.uk

NOW AVAILABLE
**TROJAN
ONLINE**

trojanonline.co.uk

